

# 3

## Convenience

### Using Apple CarPlay

<b>Apple CarPlay™</b> .....	<b>3-2</b>
Apple CarPlay™.....	3-2
<b>Android Auto™</b> .....	<b>3-6</b>
Android Auto™.....	3-6

<b>Connected Service (U.S.A. only)</b> .....	<b>3-10</b>
Connected Service Overview.....	3-10

## Apple CarPlay™

Apple CarPlay™ allows you to make calls, send or receive messages, and listen to music using your iPhone® with the Mazda Connect, or search for destinations using the maps. In addition, voice recognition using Siri® is available.

### **! WARNING**

**Do not allow the cord connected to the USB port to get tangled in the selector lever/shift lever.**

If the cord gets tangled, it could be a distraction to your driving and result in an unexpected accident.

### **! CAUTION**

- Do not place items or apply force to the USB port or console box lid with the plug connected.
- Depending on the mobile device to be connected, noise may occur when using the device with it connected to the accessory power socket equipped on the vehicle (if noise occurs, do not use the accessory power socket).
- Do not leave your iPhone® in the cabin. Otherwise, the cabin temperature will increase to a high temperature under direct sunlight which could cause damage.

### NOTE

- Before use, carefully read the user instructions for the iPhone®.
- Do not use the Mazda Connect for a long time with the engine stopped. Otherwise, the battery power could be depleted.
- Insert the Apple®-genuine connector cord into the USB port securely.

### Connecting an iPhone®

Insert an Apple®-genuine connector cord into the USB port and connect the iPhone®. Insert or pull out the plug with the plug perpendicular to the USB port.

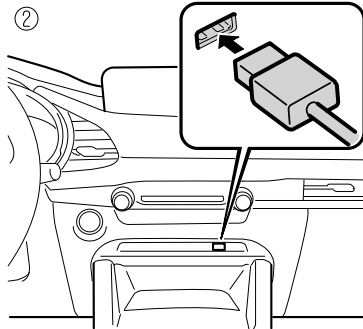
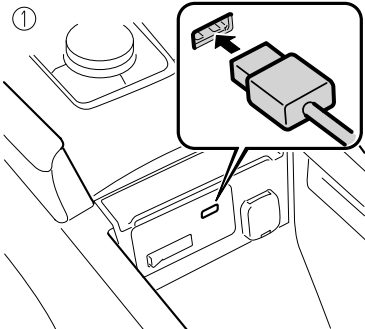

1. Located on center console

2. Located on front console

The location of the USB port differs depending on the vehicle model.

**NOTE**

- When an iPhone® connected to Bluetooth® is connected to the vehicle's USB port, the system switches to Apple CarPlay™. Applications that you were using when connected to Bluetooth® can continue to be used. However, the functions that can be used with a Bluetooth® connection and the functions which can be used by Apple CarPlay™ differ depending on the application.
- **(U.S.A./Canada)**  
 Mobile 911 can be activated even when connected to Apple CarPlay™. When using Apple CarPlay™ again after activating Mobile 911, you need to disconnect the connector cord from the USB port and then reconnect it.
- Up to 5 iPhone® devices can be registered as devices connected to Apple CarPlay™.
- When setting the Device Connection Status of a connected iPhone® to “Never Enabled”, Apple CarPlay™ will not activate even if your iPhone® is connected to the vehicle’s USB terminal. When you want to use Apple CarPlay™, change the setting. Refer to Connectivity Settings on page 2-126.

**Connecting Apple CarPlay™ for the first time**

When connecting Apple CarPlay™ for the first time, a confirmation screen concerning Apple CarPlay™ activation is displayed.



**Always Enable:** Enables Apple CarPlay™ each time without a confirmation.

**Never Enable:** Disables the currently connected device hereafter.

**Enable Once:** Enables the device only this time.

**Cancel:** Disables the device this time.

**NOTE**



If you select “Enable Once”, the confirmation screen is displayed again the next time the engine is started.

However, if the interval between stopping and starting the engine is short, the confirmation screen may not be displayed.

## Displaying the Apple CarPlay™ screen



 is displayed on the Mazda Connect home screen while Apple CarPlay™ is connected or press and hold the Home button.

Slide the  to the right while  is displayed to display the Apple CarPlay™ screen or press and hold the Home button.

### **Apple CarPlay™ home screen**

You can display the Apple CarPlay™ home screen by pressing the  on the commander switch while any Apple CarPlay™ screen is displayed or press and hold the Home button.

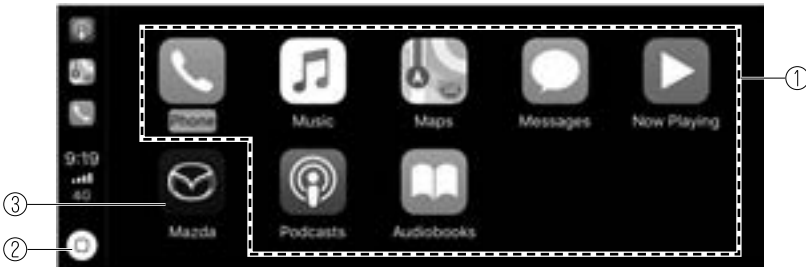



Rotate the  or slide it to select the icon you want to operate.





Press the  to activate the application of the selected icon.

**NOTE**

- The icon displayed on the Apple CarPlay™ home screen and the display position of the icons may differ depending on the connected iPhone® and iOS version or market.

No.	Icon	Explanation
1	Available CarPlay applications	Activates the Apple CarPlay™ application. Refer to the help information available with each application for the method of using each application.
2		Displays the Apple CarPlay™ Home screen. Select and hold to activate Siri®.
3		Returns to the Mazda Connect screen.

**Convenient Ways to Use Apple CarPlay™**

Item	Operation method
To Activate the voice recognition function (Siri®) *1	<p>You can operate Apple CarPlay™ using voice by activating Siri® using one of the following methods.</p> <ul style="list-style-type: none"> <li>• Press the  on the audio remote control switch.</li> <li>• Press and hold .</li> </ul>
To display the NowPlaying screen	While music is playing using Apple CarPlay™, press the  on the commander switch to return to the Apple CarPlay™ playback screen.
To display the MAP screen	During route guidance using Apple CarPlay™, press the  on the commander switch to return to the Apple CarPlay™ map screen.

\*1 The voice recognition function of Mazda Connect cannot be used while Apple CarPlay™ is connected.

**Ending Apple CarPlay™**

To end Apple CarPlay™ mode, disconnect the connector cord from the USB port or disconnect the iPhone® from the connector cord. The screen displayed before Apple CarPlay™ was activated is displayed. In addition, the Bluetooth® device connected prior to the Apple CarPlay™ activation is reconnected.

## Android Auto™

Android Auto™ is an application which allows the operation of an Android™ Smartphone using the Mazda Connect. Available contents such as the phone, messages, music, and maps that are compatible with Android Auto™ can be used with the Mazda Connect.

### **WARNING**

**Do not allow the cord connected to the USB port to get tangled in the selector lever/shift lever.**

If the cord gets tangled, it could be a distraction to your driving and result in an unexpected accident.

### **CAUTION**

- Do not place items or apply force to the USB port or console box lid with the plug connected.
- Depending on the mobile device to be connected, noise may occur when using the device with it connected to the accessory power socket equipped on the vehicle (if noise occurs, do not use the accessory power socket).
- Do not leave your Android™ Smartphone in the cabin. Otherwise, the cabin temperature will increase to a high temperature under direct sunlight which could cause damage.

### **NOTE**

- Before you use Android Auto™ with your vehicle, you need to download the Android Auto™ application from the Google Play™ on your Android™ Smartphone.
- Before use, carefully read the user instructions for the Android™ Smartphone.
- Do not use the Mazda Connect for a long time with the engine stopped. Otherwise, the battery power could be depleted.
- Insert the Android™ Smartphone genuine connector cord into the USB port securely.

## Connecting an Android™ Smartphone

Insert an Android™ Smartphone-genuine connector cord into the USB port to connect the Android™ Smartphone. Insert or pull out the plug with the plug perpendicular to the USB port.

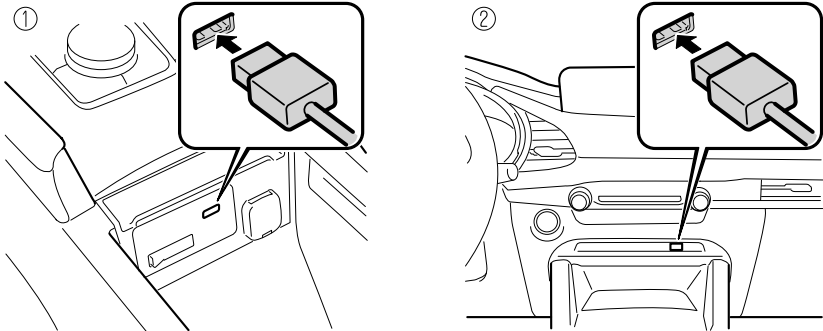

1. Located on center console
  2. Located on front console
- The location of the USB port differs depending on the vehicle model.

### **NOTE**

- To use Android Auto™, you need to enable Bluetooth®.
- The parking brake must be engaged when connecting the Android Auto™ device for the first time.
- Android™ Smartphones can be connected to Android Auto™. Up to 5 Android™ Smartphones can be registered.
- When setting the Device Connection Status of a connected Android™ Smartphone to “Never Enabled”, Android Auto™ will not activate even if your Android™ Smartphone is connected to the vehicle’s USB port. When you want to use Android Auto™, change the setting. Refer to Connectivity Settings on page 2-126.

### **Connecting Android Auto™ for the first time**

When connecting Android Auto™ for the first time, a confirmation screen concerning the Android Auto™ activation is displayed.

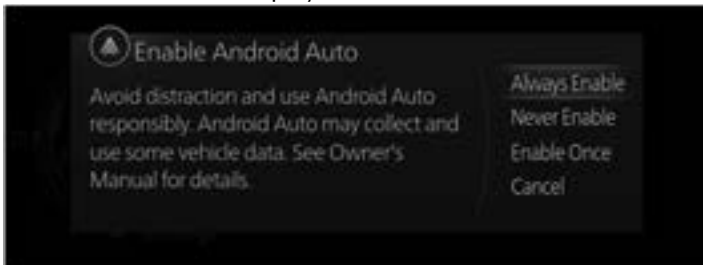

**Always Enable:** Enables Android Auto™ each time without a confirmation.

**Never Enable:** Disables the currently connected device hereafter.

**Enable Once:** Enables the device only this time.

**Cancel:** Disables the device this time.

## NOTE



If you select “Enable Once”, the confirmation screen is displayed again the next time the engine is started.

However, if the interval between stopping and starting the engine is short, the confirmation screen may not be displayed.

## Displaying the Android Auto™ screen



 is displayed on the Mazda Connect home screen while Android Auto™ is connected.

Slide the  to the right while  is displayed to display the Android Auto™ screen or press and hold the Home button to display Android Auto™.

## Android Auto™ home screen

You can display the Android Auto™ home screen by pressing the  on the commander switch while any Android Auto™ screen is displayed.

To move from the Mazda Connect screen to the Android Auto™ screen, press and hold the  on the commander switch.

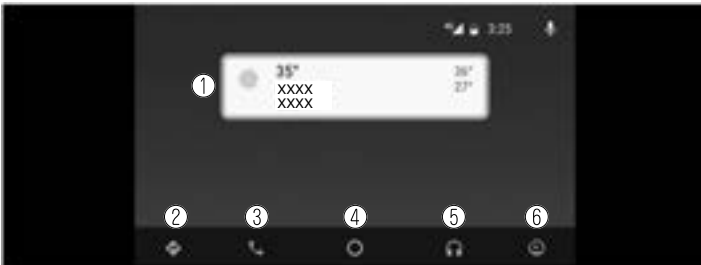





Rotate the  or slide it to select the item or icon.

Press the  to activate the application of a selected item or icon.









**NOTE**

- The media displayed on the Android Auto™ home screen may differ depending on the use conditions and version of the connected Android™ Smartphone.

No.	Icon	Explanation
1	—	Displays the information for each application. The displayed contents differ depending on the application that has been activated and its status.
2		Activates the map application.
3		Activates the call function.
4		Displays the Android Auto™ home screen.
5		Activates the music application.
6		Displays other menus. You can return to the Mazda Connect screen from the menu.

**Convenient ways to use Android Auto™**

Item	Operation method
To operate using voice*1	Any of the following methods can be used to start voice recognition mode and operate Android Auto™ using voice. <ul style="list-style-type: none"> <li>• Slide the  to the right and select the .</li> <li>• Press the   on the audio remote control switch.</li> </ul>
To display the NowPlaying screen	While music is playing using Android Auto™, press the  on the commander switch to return to the Android Auto™ playback screen.
To display the MAP screen	During route guidance using Android Auto™, press the  on the commander switch to return to the Android Auto™ map screen.
To return to the Mazda Connect screen	Press and hold  on the commander switch.

\*1 The voice recognition function of Mazda Connect cannot be used while Android Auto™ is connected.

**Ending Android Auto™**

To end Android Auto™, disconnect the connector cord from the USB port or disconnect the Android™ Smartphone from the connector cord.